

GIA COLORED DIAMOND REPORT

July 24, 2014
 Report Type Grading Report
 GIA Report Number 5176562950
 Shape and Cutting Style Pear Modified Brilliant
 Measurements 6.27 x 4.59 x 2.63 mm

 Carat Weight 0.50 carat
 Color Grade Fancy Vivid Pinkish Purple
 Color Origin Natural
 Color Distribution Even
 Clarity Grade I2
 Proportions:

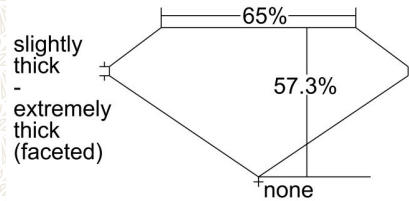

Profile not to actual proportions

Polish Excellent
 Symmetry Good
 Fluorescence None



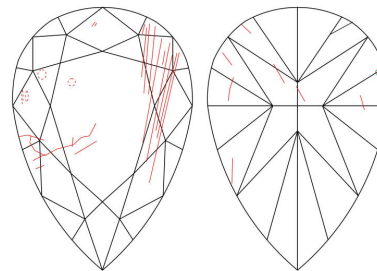

Comments: Additional clouds, pinpoints, internal graining and surface graining are not shown.

ADDITIONAL INFORMATION

CLARITY CHARACTERISTICS



KEY TO SYMBOLS*

-  Feather
-  Needle
-  Cavity
-  Cloud
-  Extra Facet

* Red symbols denote internal characteristics (inclusions). Green or black symbols denote external characteristics (blemishes). Diagram is an approximate representation of the diamond, and symbols shown indicate type, position, and approximate size of clarity characteristics. All clarity characteristics may not be shown. Details of finish are not shown.

GIA COLORED DIAMOND SCALE

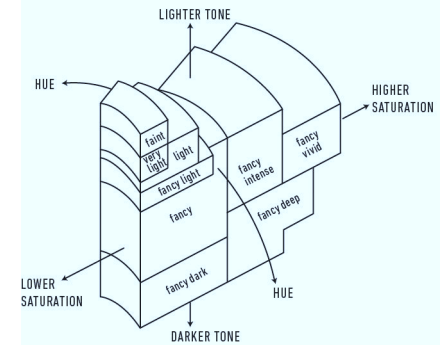

Illustration of GIA fancy color grade interrelationships

GIA CLARITY SCALE

VERY VERY SLIGHTLY INCLUDED	FLAWLESS
	INTERNALLY FLAWLESS
VERY SLIGHTLY INCLUDED	VVS ₁
	VVS ₂
SLIGHTLY INCLUDED	VS ₁
	VS ₂
INCLUDED	SI ₁
	SI ₂
	I ₁
	I ₂
	I ₃



reportcheck.gia.edu



The results documented in this report refer only to the diamond described, and were obtained using the techniques and equipment used by GIA at the time of examination. This report is not a guarantee or valuation. For additional information and important limitations and disclaimers, please see www.gia.edu/terms or call +1 800 421 7250 or +1 760 603 4500. ©2014 Gemological Institute of America, Inc.

 THE SECURITY FEATURES IN THIS DOCUMENT, INCLUDING THE HOLOGRAM, SECURITY SCREEN AND MICROPRINT LINES, IN ADDITION TO THOSE NOT LISTED, EXCEED DOCUMENT SECURITY INDUSTRY GUIDELINES.